

The class of the built-in wall must at least correspond to the bullet resistance class of the door.

Detail Glazing / base
see vertical cross-section



FRANZEN
Feuerschutztüren

Zechenring 23; 41836 Hückelhoven

**Single-leaf bullet-resistant
security door FB4
"System Schröders FBN-1"**

horizontal cross-section

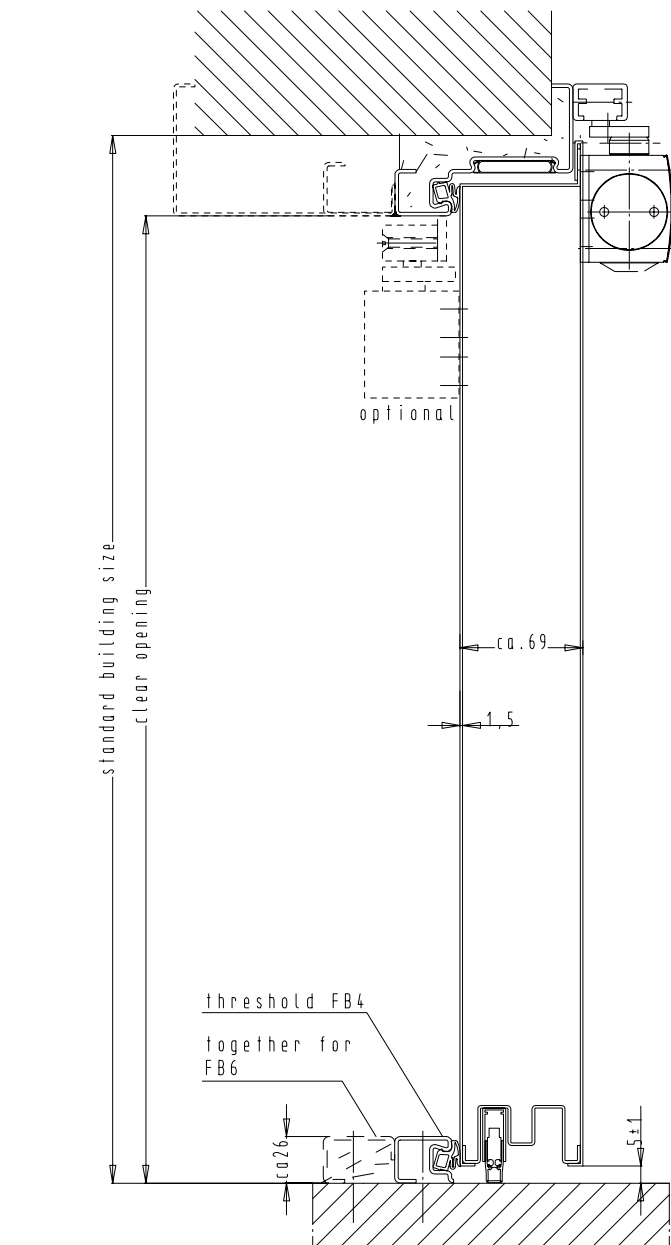

square glazing

clear view 450 x 450 up to
<700 x <1000
(Pay attention to weight!!!
ca. 123kg/m²)

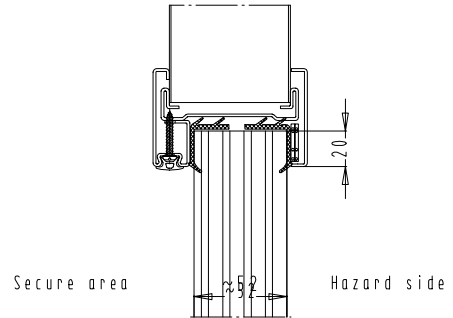

Glass pane
(only) FB4
Typ Promaglas BR4 NS

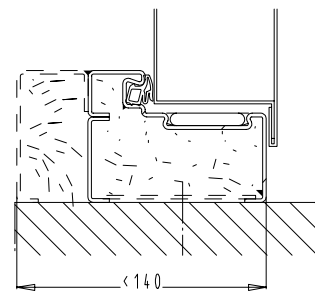
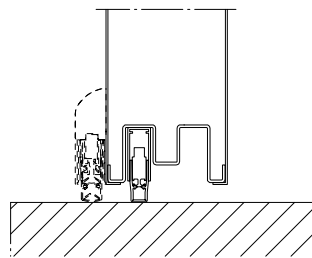
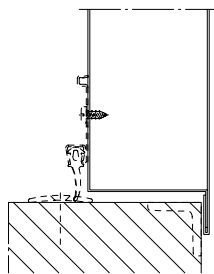
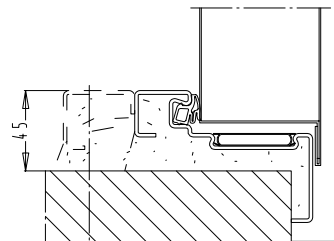
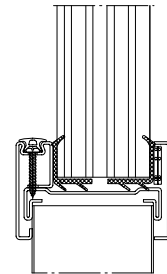

installation and frame variants
see horizontal cross-section



FRANZEN
Feuerschutztüren

Zechenring 23; 41836 Hückelhoven

**Single-leaf bullet-resistant
security door FB4**

"System Schröders FBN-1"

vertical cross-section